

## HX3

---

Wearable Computer

With Microsoft Windows® CE 5.0 Operating System

## Quick Start Guide



# HX3 Rugged Voice Computer

Tethered  
Ring



HX3



Headset



Remove  
Shipping  
Film

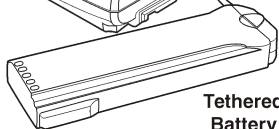

Tethered  
Battery

# Components - Front

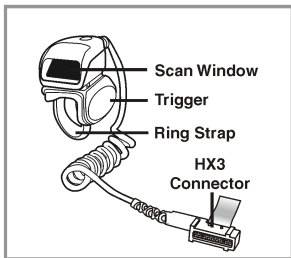
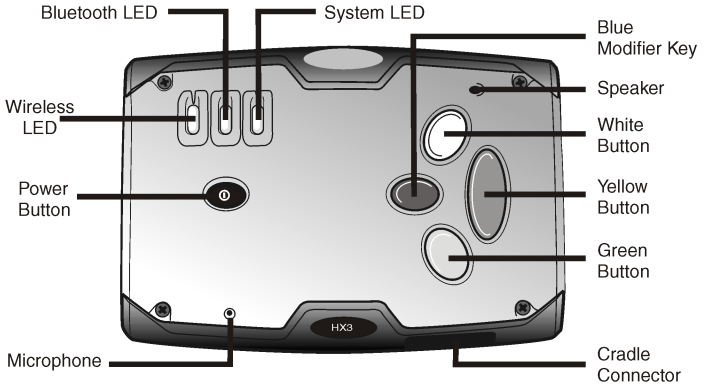

**Laser Scanner**

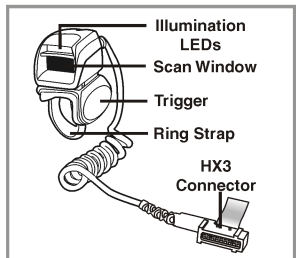

**Laser Imager**

User Replaceable - Trigger module and ring strap module.

## Components - Back

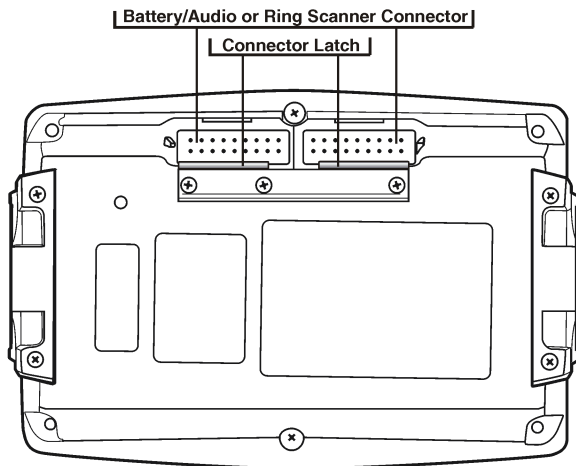

## Attach Audio/Power Cable to HX3

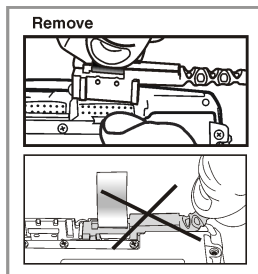
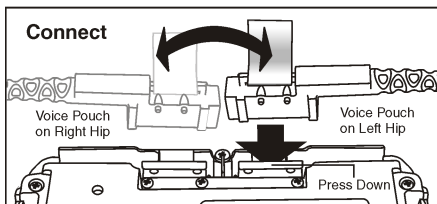
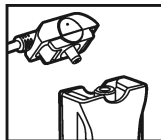
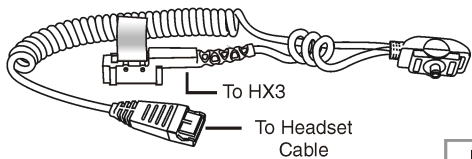

## Connect Battery and Audio Cable

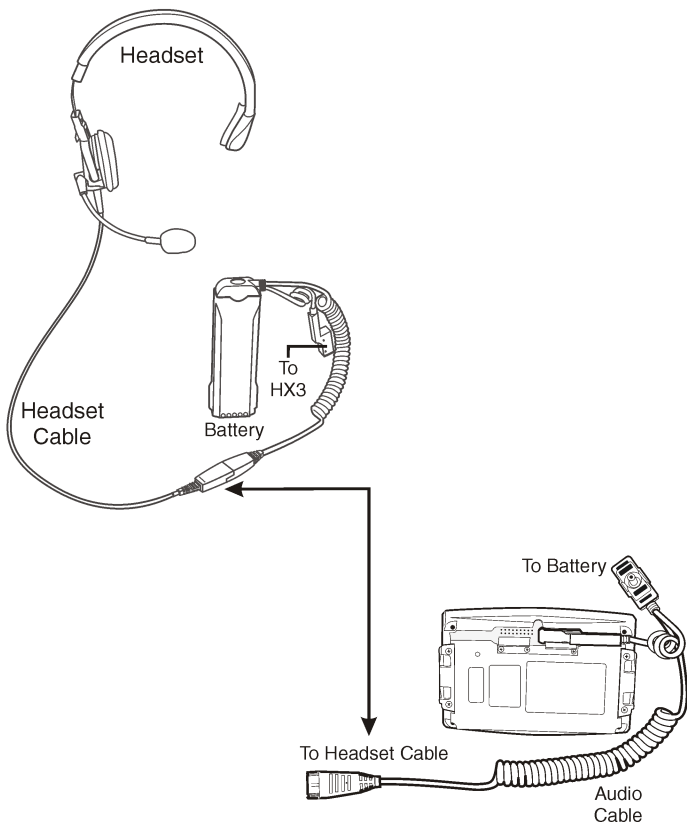

## Trigger Rotation

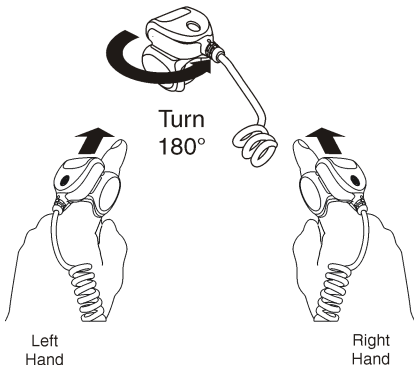

## Attach Ring to Finger

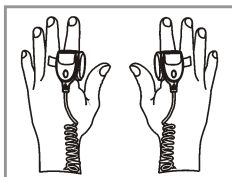
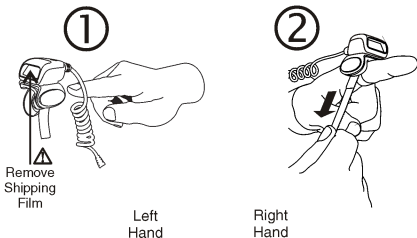

## Attach Ring Cable to HX3

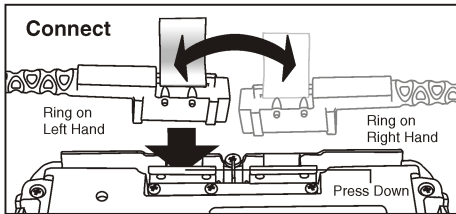
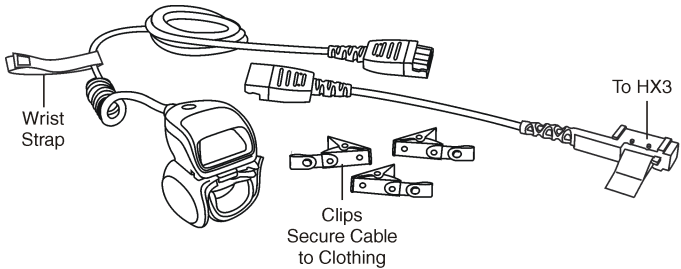

## Remove

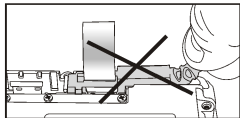
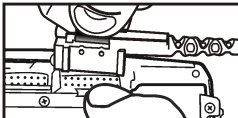



## Voice Pouch, Headset and Ring Scanner

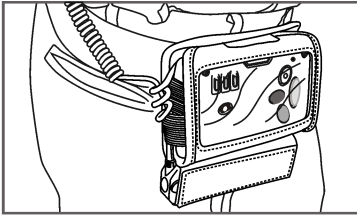

Standard Battery Placement

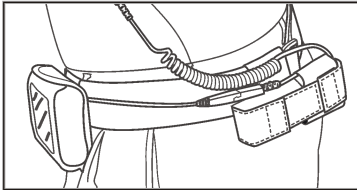

Alternative Battery Placement

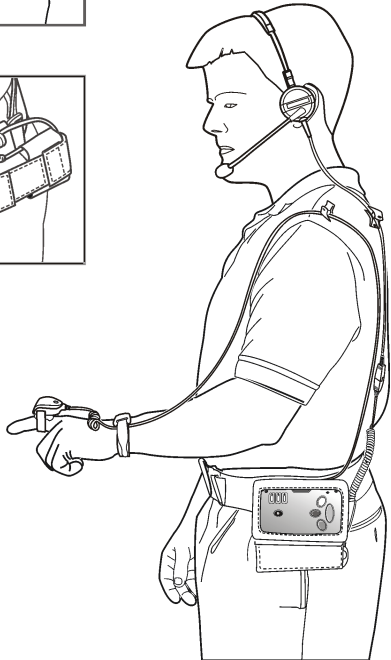

## Alternative Battery Placement

Battery Kit Assembly

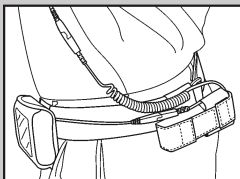
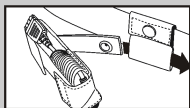
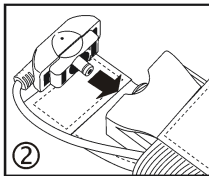
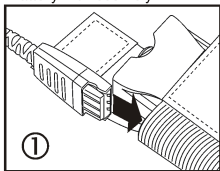

Alternative Battery Placement

## Scanning a Bar Code

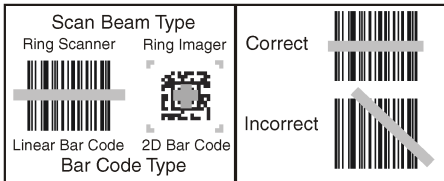
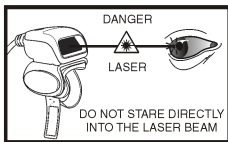

### Important

To pair the HX3 with a Wireless Handheld Bluetooth Scanner – scan the linear bar code label on the HX3, that begins with LnkB, with the Wireless Handheld Bluetooth Scanner.



LnkB054003506750



LnkB054003506750



## Desktop Cradle

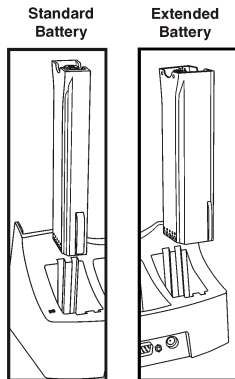
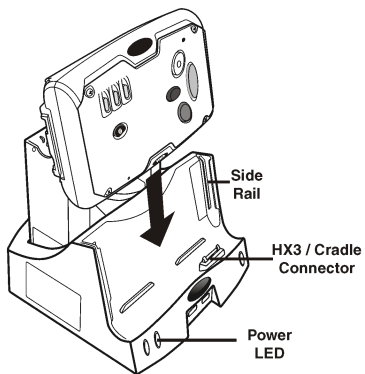

## Battery Multi-Charger

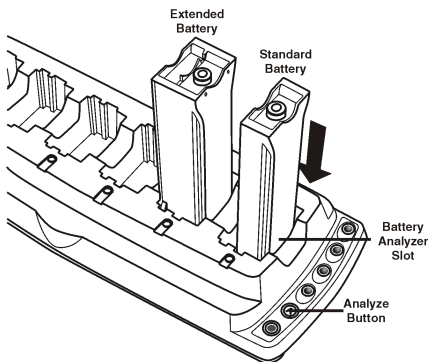

## Remove Ring Strap Module

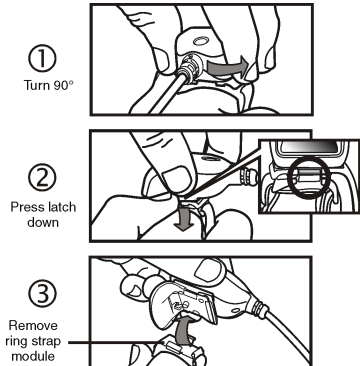

## Remove Trigger Module

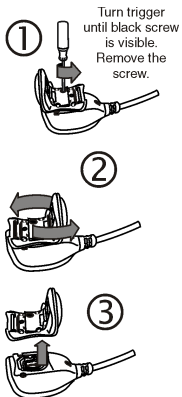

## Replace Ring Strap Module

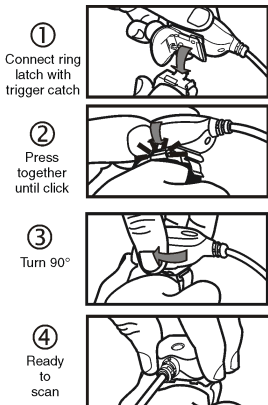

## Replace Trigger Module



## Setting up the HX3

Please have the following information available before setting up your HX3:

- Network ID (SSID) of the Access Point
  - WEP key or LEAP authentication credentials
1. Connect a fully charged battery to the HX3.
  2. Press the Power button.
  3. Connect via ActiveSync
  4. Copy LXEConnect files to PC.
  5. Install and launch LXEConnect
  6. Accept the EULA.
  7. Set the date and time.
  8. Edit the radio parameters.
  9. Perform a reboot.

## Bluetooth and HX3

Please refer to the HX3 Reference Guide for information when using the HX3 with Bluetooth.

## ActiveSync

### Installing ActiveSync on Desktop/Laptop

ActiveSync (version 4.5 or higher for Windows XP desktop/laptop computers) must be resident on the host (desktop/laptop) computer. Windows Mobile Device Center is required for a Windows Vista/Windows 7 desktop/laptop computer. ActiveSync and Windows Mobile Device Center for the PC are available from the Microsoft website. Follow Microsoft's instructions to locate, download and install ActiveSync or Windows Mobile Device Center on your desktop/laptop.

### ActiveSync using USB-Client Connection

The only connection type is USB Client.

1. Connect the HX3 end of the cable to the connector on the bottom of the HX3.
2. Connect the USB type A connector on the I/O cable to a USB port on a PC or laptop.

ActiveSync starts automatically when the USB cable is connected.

When the HX3 loses connection, the connection to ActiveSync is lost. Disconnect the PC end of the cable and re-connect.

Please refer to the HX3 Reference Guide for ActiveSync information.

# LXEConnect

## Install LXEConnect

1. Establish an ActiveSync connection between the HX3 and a laptop/desktop.
2. Select **Explore** (ActiveSync) or **File Management** (Windows Mobile Device Center) from the PC interface.
3. Browse to the \System\LXEConnect folder on the HX3 using the explorer dialog box.
4. Copy the **LXEConnect.msi** and **Setup.exe** files from the HX3 to the PC.
5. Close the explorer dialog box.
6. Execute the **Setup.exe** file that was copied to the PC.
7. Follow the on screen prompts to install LXEConnect.

## Using LXEConnect

1. Establish an ActiveSync connection to the HX3 if one does not exist.
2. Launch LXEConnect from the PC by selecting **Start > Programs > LXE > LXEConnect**.
3. LXEConnect launches and displays the HX3 desktop.
4. The HX3 can be configured from the LXEConnect window. Input from the PC's keyboard and mouse are recognized as if they were attached to the HX3.
5. Click the **OK** button to dismiss the About CERDisp dialog box. The dialog box automatically times out after approximately 30 seconds if no action is taken.
6. If any parameter changes were made, warmboot the HX3 by clicking  > **Run**. Type **warmboot** and click **OK**.
7. Select **File > Exit** or click the **X** in the upper right hand corner to close LXEConnect and then disconnect the ActiveSync session.

Warmbooting the HX3 terminates the ActiveSync connection. To make additional changes to the HX3, reconnect the ActiveSync cable and launch LXEConnect again.

## Rebooting the HX3

Using the Start menu, select **Start > Run** and type **warmboot** in the text box. Press **Enter**.

When the HX3 is booting, there may be small delays while the wireless client connects, applications launch, remote management completes and Bluetooth devices connect.

## Setting Up the Radio

If the access point uses an authentication protocol (WEP, LEAP, etc.), your radio must use the same authentication. Please contact your IT department for WEP keys or LEAP credentials. Please refer to the HX3 Reference Guide for information on using WPA.

1. Tap **Start > Programs > Summit > SCU** OR tap the Summit Client Utility icon on the desktop.
2. Tap the **Admin Login** button and enter the password (default = SUMMIT).
3. Tap the **Profile** tab and make sure the Default profile is selected.
4. Select **SSID** and enter your SSID value.
5. If the access point is using WEP, select **WEP** from the Encryption pull down list.
6. Tap the **WEP keys/PSKs** button and enter the WEP Key(s) and tap **OK**. Skip to step 12.
7. If the access point is using LEAP, select **LEAP** from the EAP Type pull down list.
8. Select **WEP EAP** from the Encryption pull down list.
9. If the Cisco/CCS certified AP is configured for open authentication, set the **Auth Type** radio parameter to **Open**.
10. If the AP is configured for network EAP only, set the **Auth Type** radio parameter to **LEAP**.
11. Tap the **Credentials** button and enter the User Name and Password.
12. Tap the **Commit** button to save the radio configuration.
13. Tap the **Main** tab. Wait for a radio connected message.
14. Tap the **Admin Logout** button when finished.
15. Reboot the HX3.

Please refer to the Radio Mode parameter in the HX3 Reference Guide. It is important that this parameter setting corresponds to the Access Point to which the HX3 connects.

## **Disclaimer**

Honeywell International Inc. (“HII”) reserves the right to make changes in specifications and other information contained in this document without prior notice, and the reader should in all cases consult HII to determine whether any such changes have been made. The information in this publication does not represent a commitment on the part of HII.

HII shall not be liable for technical or editorial errors or omissions contained herein; nor for incidental or consequential damages resulting from the furnishing, performance, or use of this material.

This document contains proprietary information that is protected by copyright. All rights are reserved.

© 2007-2012 Honeywell International Inc. All rights reserved.

Other product names or marks mentioned in this document may be trademarks or registered trademarks of other companies and are the property of their respective owners.

Web Address: [www.honeywellaidc.com](http://www.honeywellaidc.com)

## **Patents**

For patent information, please refer to [www.honeywellaidc.com/patents](http://www.honeywellaidc.com/patents).

## **Technical Assistance**

Contact information for technical support, product service, and repair can be found at [www.honeywellaidc.com](http://www.honeywellaidc.com).

## **Limited Warranty**

Refer to [www.honeywellaidc.com/warranty\\_information](http://www.honeywellaidc.com/warranty_information) for your product’s warranty information.

## **User Documentation**

To download the HX3 user documentation go to [www.honeywellaidc.com](http://www.honeywellaidc.com).